



**DA SERIES - UNCASSED UPFLOW/DOWNFLOW ALUMINUM COILS**  
**DC SERIES - CASSED UPFLOW/DOWNFLOW ALUMINUM COILS**  
**DE SERIES - CASSED MULTI-POSITION ALUMINUM COILS**  
**DM SERIES - UNCASSED DOWNFLOW ALUMINUM COILS FOR USE WITH MANUFACTURED HOME FURNACES**

## Contents

1. Important Safety Instructions
2. Inspection
3. Codes & Regulations
4. Installation Preparation
5. Condensate Drain Preparation
6. Coil Installation
  - 6A. Vertical Upflow/Downflow Installation
  - 6B. Horizontal Installation
7. Suction Line Connection
8. Metering Devices/Liquid Line Connection
  - 8A. Flowrator Coils
  - 8B. TXV Coils
9. Leak Check
10. System Charging
11. Coil Cleaning Instructions
12. A2L Refrigerant Detections Systems
  - 12.1 Installation, Service, Maintenance & Repair Instructions
    - 12.1.1 Qualification of workers
    - 12.1.2 Checks to the work area & Work procedure
    - 12.1.3 Checking for presence of refrigerant
    - 12.1.4 Presence of Fire Extinguisher
    - 12.1.5 No Ignition Sources
    - 12.1.6 Ventilated Area
    - 12.1.7 Checks to the refrigerating equipment
    - 12.1.8 Checks to electrical devices
    - 12.1.9 Repairs to sealed electrical components
    - 12.1.10 Cabling
    - 12.1.11 Detection of Flammable Refrigerants
    - 12.1.12 Removal and Evacuation
    - 12.1.13 Charging Procedures
    - 12.1.14 Decommissioning
    - 12.1.15 Labeling
    - 12.1.16 Recovery
  - 12.2 RDS Sensor, Mitigation Control, and Wiring
  - 12.3 RDS Installation of Sensor, Mitigation Control, and Wiring
13. Wiring Diagrams

## 1. Important Safety Instruction

Potential safety hazards are alerted using the following symbols. The symbol is used in conjunction with terms that indicate the intensity of the hazard. It is the responsibility of the owner and the installer to read and comply with the safety information and the instructions accompanying these symbols.



Read the precautions in this manual carefully before operating the unit.



Read the instructions in this manual carefully before operating the unit.



Read the instructions in this manual carefully before servicing the unit.



Read the instructions in this manual carefully before wiring the unit.



Warning or Caution



### WARNING

This symbol indicates a potentially hazardous situation, which if not avoided, could result in serious injury, property damage, product damage or death.



### CAUTION

This symbol indicates a potentially hazardous situation, which if not avoided, may result in moderate injury or property damage.



### WARNING

Certified technicians or those individuals meeting the requirements specified by NATE may use this information. Property and product damage or personal injury hazard may occur without such background.

This appliance is not intended for use by persons (including children) with reduced physical, sensory, or mental capabilities, or lack of experience and knowledge, unless they have been given supervision or instruction concerning use of the appliance by a person responsible for their safety.

Children must be supervised to ensure that they do not play with the appliance.

Product designed and manufactured to permit installation in accordance with local and national building codes. It is the installer's responsibility to ensure that the product is installed in strict compliance with the aforementioned codes. Manufacturer assumes no responsibility for damage (personal, product or property) caused due to installations violating regulations.



### WARNING

Disconnect **ALL** power before servicing or installing this unit. Multiple power sources may be present. Failure to do so may cause property damage, personal injury, or **death**.



### WARNING

Do not bypass safety devices.



### WARNING

Do not use means to accelerate the defrosting process or to clean, other than those recommended by the manufacturer. The appliance shall be stored in a room without continuously operating ignition sources (for example: open flames, an operating gas appliance or an operating electric heater). Do not pierce or burn. Be aware that refrigerants may not contain an odor.



### WARNING

If any hot work is to be conducted on the refrigerating equipment or any associated parts, appropriate fire extinguishing equipment shall be available to hand. Have a dry powder or CO2 fire extinguisher adjacent to the charging area.

This appliance is not intended for use at altitudes exceeding 2,000 meters.

## 2. Inspection

On receiving the product, visually inspect it for any major shipping related damages. Shipping damages are the carrier's responsibility. Inspect the product labels to verify the model number and options are in accordance with your order. The manufacturer will not accept damage claims for incorrectly shipped product.

Product design for use with A1 refrigerant are marked with R410A refrigerant specified on the nameplate.

Product design for use with A2L refrigerant are marked with R32 or R454B refrigerant specified on the nameplate, and the product will be marked with the following symbols:



Figure 2-1

Product design for use with A2L refrigerant are equipped with an A2L refrigerant detection system (RDS), which includes A2L Sensor, Mitigation Control Board, and Wiring Harnesses. Refer to Section 12 of this manual wiring and operation instructions.

## 3. Codes & Regulations

This product is designed and manufactured to comply with national codes. The product shall be installed in accordance with national wiring regulations. It is the responsibility of the installer to follow such codes and / or prevailing local codes / regulations. Compliance with national gas regulations shall be observed. The manufacturer assumes no responsibility for equipment installed in violation of any codes or regulations.

## 4. Installation Preparation

Read all the instructions in this guideline carefully while paying special attention to the WARNING and CAUTION alerts. If any of the instructions are unclear, clarify with a certified technician before proceeding. Gather all tools needed for successful installation of the unit prior to beginning the installation.



### NOTICE

Absence of pressure/charge does not verify a leak. Check coils for leaks prior to installation.

Assure that the maximum operating pressure is considered when connecting any evaporator unit or condenser unit.

Refer to Section 10 of this manual for refrigerant charging instructions.



### WARNING

**PARTIAL UNITS** shall only be connected to an appliance suitable for the same refrigerant.

This product family Models DA/DC/DE/DM are PARTIAL UNIT AIR CONDITIONERS, complying with PARTIAL UNIT requirements of UL 60335-2-40 Standard, and must only be connected to other units that have been confirmed as complying to corresponding PARTIAL UNIT requirements of this Standard (UL 60335-2-40).

The appliance shall be installed in accordance with national regulations. This product was tested at an external static pressure of 0.66" W.C. None of the components in this product family are designed or approved to be suitable for outdoor use.

Refrigerant lines must be routed to allow the minimum required clearance of 24" for service. Consult all appropriate regulatory codes prior to determining final clearances.

## 5. Condensate Drain Preparation

Aspen recommends an auxiliary drain pan be provided and installed by the installing contractor, which should be properly sloped, installed according to code, and terminated in an area visible to the homeowner. The auxiliary pans provide extra protection to the area under the unit should the primary and secondary drain plug up and overflow.



### WARNING

As expressed in our product warranty; ASPEN WILL NOT BE BILLED FOR ANY STRUCTURAL DAMAGES CAUSE BY FAILURE TO FOLLOW THIS INSTALLATION REQUIREMENT.



### CAUTION

Drain lines from the auxiliary drain pan should NOT be connected to the primary drain line of the coil.



### WARNING

Do NOT install coils with standard temperature drain pan with oil furnaces or applications where temperature of the drain pan might exceed 290 °F. A metal pan should be installed. Failure to follow this warning may result in property damage and/or personal injury.

Install coils with the drain pan and/or casing on a flat, level surface. Slope the coil 1/4" towards the drain. Condensate lines must be installed in accordance with building codes. It is the contractor's responsibility to ensure proper condensate drainage at the time of the installation; Aspen bears no responsibility for damages caused by improper condensate management.

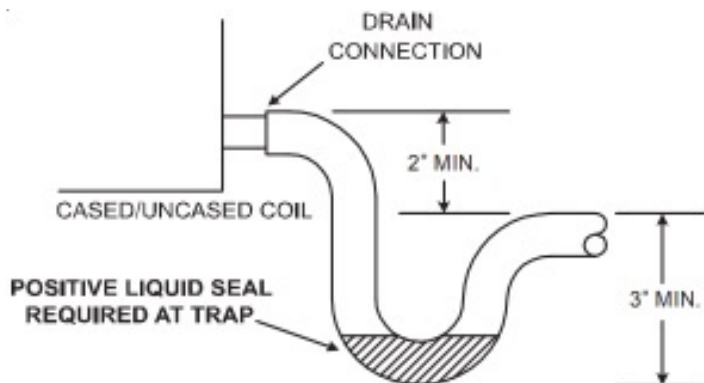


### CAUTION

Some coils have primary and secondary drain ports on both sides of the pan to offer installation flexibility, so ensure all threaded plugs are in present and tightened in any unused drain ports. These may be hidden behind the coil casing access door. Failure to do so may result in property water damage; it is the contractor's responsibility to ensure these plugs are present and tight.

The drain lines must be installed with 1/4" per foot pitch to provide free drainage. A condensate trap MUST be installed on the primary drain line to ensure proper drainage of the condensate. The trap must be installed in the drain line below the bottom of the drain pan. Fig. 4-1 illustrates the typical drain trap installation. Prior to installation, ensure drain pan hole is not obstructed. Additionally, Aspen recommends the drain lines be insulated to prevent sweating and dripping.

**Fig 5-1. Typical drain line trap setup**



### CAUTION

Use Teflon tape to connect the drain lines to the threads in the drain pan. DO NOT USE SOLVENT BASED PIPE DOPE. THIS WILL REDUCE THE LIFE OF THE PAN.

The drain pan has primary (white) and secondary (red) drain connections. If a secondary drain line is required, it should be run separately from the primary and should terminate in a highly visible location. Condensate disposal through the secondary drain line indicates that the primary drain line is plugged and needs cleaning. If a secondary drain line will not be provided, plug the secondary drain. Drain plugs are NOT to be reused without plumbers' tape or putty. Drain line connection should be finger tightened, then turned no more than one complete turn as needed to ensure a firm connection. DO NOT overtighten connection or damage may occur.

## 6. Coil Installation



### WARNING

The coil is manufactured with dry nitrogen pre-charge. Release the pressure through the Schrader valve test port prior to installation. If holding pressure is not present, return coil to distributor for exchange.



### NOTICE

Refrigerant tubing must be routed to allow accessibility for service and maintenance of the unit.

Pipe-work including piping material, pipe routing, and installation shall include protection from physical damage in operation and service, and be in compliance with national and local codes and standards, such as ASHRAE 15, ASHRAE 15.2, IAPMO Uniform Mechanical Code, ICC International Mechanical Code, or CSA B52. All field joints shall be accessible for inspection prior to being covered or enclosed.



### WARNING

For coils using A2L FLAMMABLE REFRIGERANTS, when installed in a room with an area less than that outlined in Table 12.2A for R32 and Table 12.2B for R454B. That room shall be without continuously operating open flames (for Example an operating gas appliance) or other potential ignition sources (for example an operating electric heater, hot surfaces). A flame providing device that may be installed in the same space if the device is provided with an effective flame arrest.

After completion of field piping for split systems, the field pipe-work shall be pressure tested with an inert gas and then vacuum tested prior to refrigerant charging, according to the following requirements:

The minimum test pressure for the low side of the system shall be the low side design pressure and the minimum test pressure for the high side of the system shall be the high side design pressure, unless the high side of the system, cannot be isolated from the low side of the system in which case the entire system shall be pressure tested to the low side design pressure.

Field-made refrigerant joints indoors shall be tightness tested. The test method shall have a sensitivity of 5 grams per year of refrigerant or better under a pressure of at least 0.25 times the maximum allowable pressure. No leak shall be detected. REFER TO SECTION 10 FOR SYSTEM CHARGING INSTRUCTIONS.

Clean coil fins with degreasing agent or mild detergent and rinse fins clean prior to installation. Refer to Section 10 of this manual for coil cleaning / maintenance guidance.

The refrigerant line sizes should be selected according to the recommendations of the outdoor unit manufacturer.

Care must be taken to ensure all connection joints are burr-free and clean. Failure to do so may increase chances of a leak. It is recommended to use a pipe cutter to remove the spun closed end of the suction line.

To reduce air leakage, rubber grommets may be present where the lines pass through the coil case. To avoid damage, remove grommets prior to brazing by sliding over the lines. Use a quenching cloth or allow the lines to cool before reinstalling the grommets.

Use of wet rags/quenching cloth is highly recommended to prevent weld-related damage to the casing and Schrader valve (if present).

Can be installed in either an upflow or a downflow application.

**CAUTION** Coil should be installed on the discharge side of the furnace.

**CAUTION** Aspen coils may include a Schrader valve on the suction manifold. Ensure that the Schrader valve and valve core (where present) are protected from heat to prevent leakage.

**NOTICE** Refrigerant tubing must be routed to allow accessibility for service and maintenance of the unit.

**WARNING** As mentioned elsewhere in this document, in an application involving oil furnace a metal drain pan **MUST** be used. Coils installed on an oil furnace must have a minimum of six inches clearance between the top of the furnace and bottom of the drain pan.

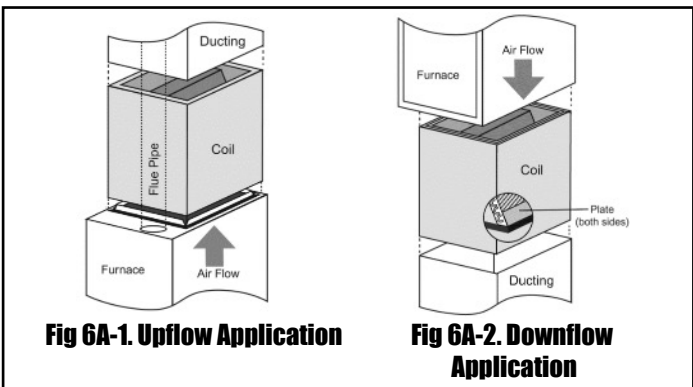
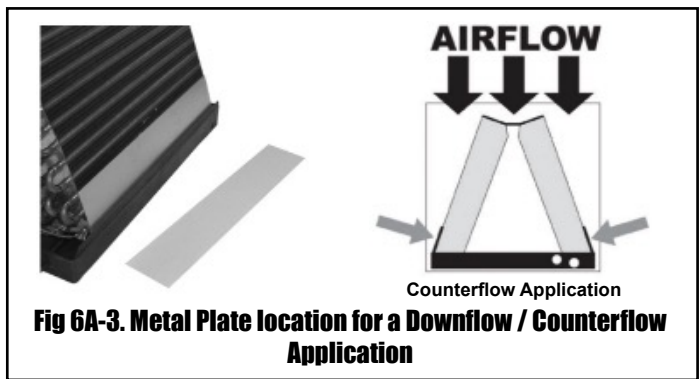
**CAUTION** Multi-position Coils are shipped from the factory for specific horizontal applications (horizontal right or horizontal left). Installer must ensure that the coil is installed in the orientation for which it was intended (horizontal drain pan side down). Failure to follow these instructions might lead to property and equipment damage.

### 6A. Vertical Upflow/Downflow Installation (DA, DC, DE)

**CAUTION** When installing in conjunction with a gas furnace in a vertical orientation, ensure that there is 2" gap between the bottom of the drain pan and the outlet of the furnace.

To set up coils for downflow application, install the two 3" wide by 16" long galvanized metal plates on the outside of the coil, against the fins on each side of the coil as shown in Fig. 5A-3. These plates are supplied with the coil.

**Do NOT exceed 350 cfm/ton of airflow for downflow applications.**



To position the coil on furnace:

1. Locate the air outlet of the furnace
2. Adjust flanges accordingly and position the coil over or under the furnace outlet.
3. Place ductwork over the casing.

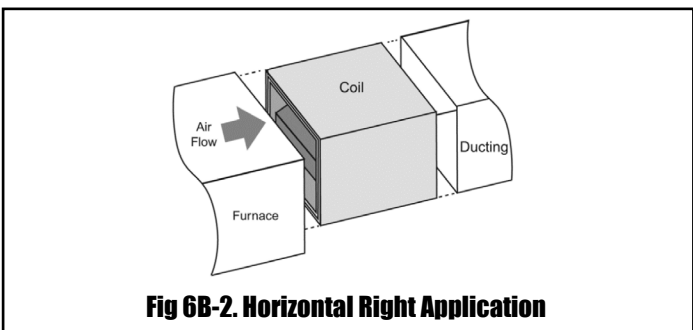
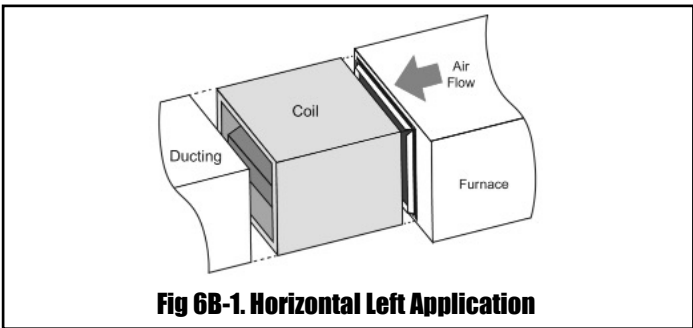
Refer to Furnace/Air Handler manufacturer literature for specific coil installation guidelines and recommendations.

**NOTICE** When installing uncased coil on top of furnace a field fabricated 2.0" to 6.0" spacer (placed between the furnace exit and the inlet of the evaporator) should be installed.

### 6B. Horizontal Installation (DE ONLY)

Multi-position coils are shipped from the factory such that they can be installed in both vertical and horizontal applications without changes to the coil. When installing these coils in the horizontal application, the details mentioned in this section must be followed.

Multi-position coils come equipped with a horizontal drain pan (Plastic/Metal). The plastic drain pan is protected from high temperatures by a metal plate at the apex end of the coil.



Refer to Furnace/Air Handler manufacturer literature for specific coil installation guidelines and recommendations.

**NOTICE** Due to higher designed radiant heat, a field fabricated 6.0" spacer (placed between the furnace exit and the inlet of the evaporator) should be installed when matching up an Aspen coil with an ultra-low NOx (ULN) furnace.

## 7. Suction Line Connection



### NOTICE

Coils designed for use with A2L Refrigerant are marked with a red tag on the suction and liquid stubs. This marking must be removed prior to brazing and shall be replaced after brazing.



### WARNING

The sensing bulb and TXV body **MUST** be protected from overheating during brazing. The sensing bulb and TXV body must be covered using a quench cloth or wet cloth when brazing. Pointing the brazing flame away from the valve and sensing bulb provide partial protection only.



### CAUTION

Aspen coils may include a Schrader valve on the suction manifold. Ensure that the Schrader valve and valve core (where present) are protected from heat to prevent leakage.

1. Ensure suction line connection joints are burr-free and clean. Failure to do so may increase chances of a leak and introduce contaminants to the system. It is recommended to use a pipe cutter to remove the spun closed end of the suction line.
2. Swage (or use a field supplied coupler) and braze the field supplied refrigerant suction line tubing to the coil stub using approved industry practices.



### WARNING

Do not attempt to touch brazed joints while hot. Severe burns may result.

## 8. Metering Devices/Liquid Line Connection

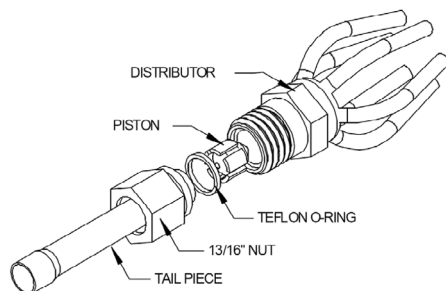


### NOTICE

Coils designed for use with A2L Refrigerant are marked with a red tag on the suction and liquid stubs. This marking must be removed prior to brazing and shall be replaced after brazing.

Aspen coils are available with two kinds of metering devices a) flowrator or b) TXV. The following instructions are separated into sections by metering device.

### 8A. Flowrator Coils



**Fig 8A-1. Flowrator assembly components**



### CAUTION

Use Piston sizes recommended by the outdoor unit manufacturer whenever possible. The piston should be sized according to the capacity of the outdoor unit.

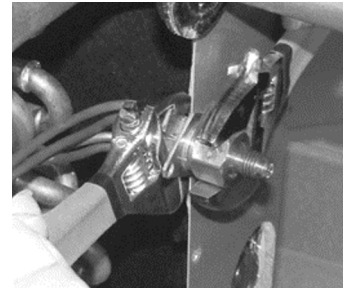


### WARNING

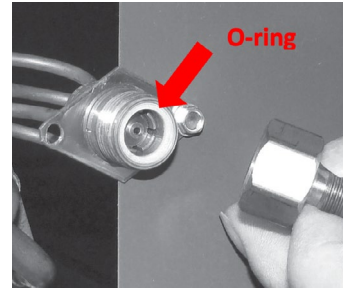
Failure to install the proper piston can lead to poor system performance and possible compressor damage.

#### I. Installation

*NOTE: Photos are for basic illustration / reference purposes only. Actual equipment configuration may differ from that shown.*



- I-1. Disassemble flowrator body using two wrenches and unscrewing with a counterclockwise motion.

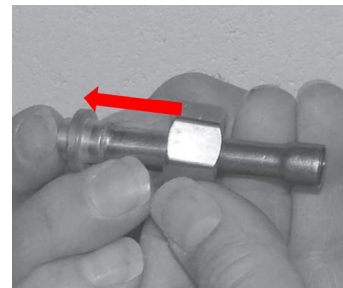


- I-2. Replace the Teflon O-ring (located between the halves). Discard Schrader if present.



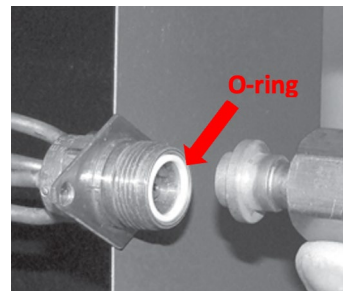
### CAUTION

Be aware of the Teflon O-ring. Be sure to replace the O-ring to attain a proper seal. (The Teflon O-ring is located between the two halves of the flowrator)



- I-3. Slide the attachment nut onto the liquid line stub out.

- I-4. Braze the stub-out portion to the liquid line and let cool.



- I-5. Taking care that the white Teflon seal is still in place inside the flowrator body, firmly seat the stub and screw the attachment nut to flowrator body.

- I-6. Tighten nut using no more than 10 ft-lbs of torque. A flare nut open end wrench is recommended to evenly distribute the force across all six sides of the nut to ensure piston body is not deformed.

#### II. Piston Replacement

*NOTE: Photos are for basic illustration / reference purposes only. Actual equipment configuration may differ from that shown.*



**Fig 7A-2**

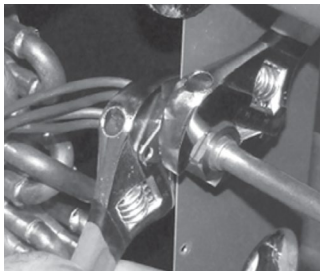
During some installations, a piston change may be required. If so, the installer **MUST** change the piston. Use piston sizes recommended by the outdoor unit manufacturer. If a sizing chart is not available, use the piston size chart provided below to size the required piston. The size of the piston is stamped on the piston body (Fig 7A-2).

Use the chart below when matching coil with an outdoor unit with a different nominal capacity than the coil.

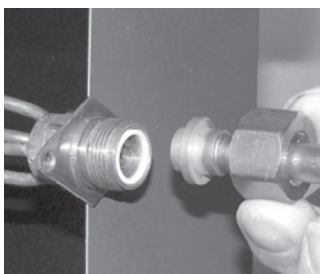
Outdoor Unit Capacity	R410A Orifice Size
12,000	N/A
18,000	0.049
24,000	0.055
30,000	0.059
36,000	0.068
42,000	0.074
48,000	0.080
60,000	0.089

II-1. Evacuate the system as per manufacturer guidelines and recommendations.

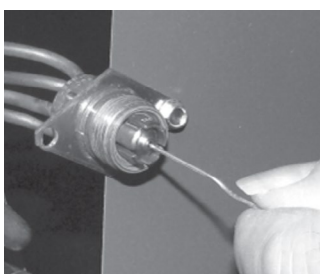
II-2. Turn the 13/16" nut once to release any residual pressure in the coil.



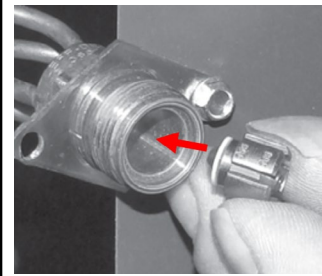
II-3. After ensuring that the coil is free of any residual pressure, disassemble the flowrator body completely using two wrenches. Take great care not to distort the feeder tubes. The wrench used to clasp the nut should be turned in counterclockwise direction to unscrew the nut.



II-4. Slide the 13/16" nut over the lineset and separate the two halves of the flowrator.



II-5. Pull the piston out using a small wire or pick. Verify the piston size (size is typically stamped on the body of the piston - Fig 7A-2). If a different piston size is required by the outdoor unit manufacturer, replace the piston using the small wire provided with the piston kit.



II-6. Replace the piston with one of the correct size. Do not force the new piston into the body. Make sure the piston moves freely in body.



**CAUTION**

Pay close attention to the piston orientation. The pointed end of the piston **MUST** go into the distributor body, towards the coil. Failure to ensure this orientation will cause the piston to be bypassed during operation which might damage the outdoor unit.

II-7. Assemble the two halves correctly and ensure that the Teflon O-ring is present between the two halves (See I-5). Slide the 13/16" nut onto the distributor body.



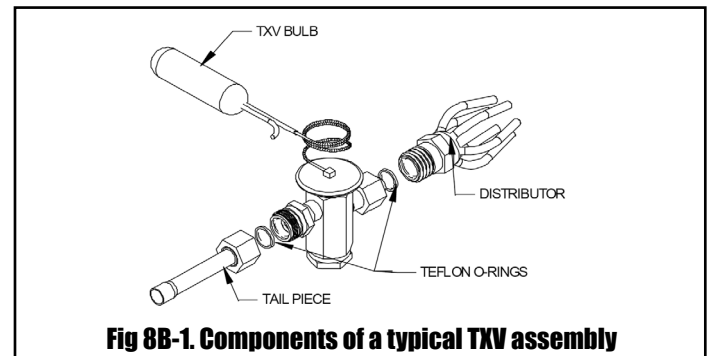
**CAUTION**

Be aware of the Teflon O-ring. Be sure to replace the O-ring to attain a proper seal. (The Teflon O-ring is located between the two halves of the flowrator).

II-8. Tighten the nut to a torque of approximately 10 ft-lbs. Do NOT overtighten the nut. Overtightening could crack the nut and/or impede the piston movement during operation.

II-9. If present, slide the rubber grommet back to position to prevent air leakage.

**8B. TXV Coils**



**Fig 8B-1. Components of a typical TXV assembly**



**WARNING**

The sensing bulb and TXV body **MUST** be protected from overheating during brazing. The sensing bulb and TXV body must be covered using a quench cloth or wet cloth when brazing. Pointing the brazing flame away from the valve and sensing bulb provide partial protection only.



**CAUTION**

Ensure that the TXV selected is compatible with the refrigerant used in the outdoor system. The TXV body is marked with R410A, R454B, or R32.



**CAUTION**

The valves should be sized according to the capacity of the outdoor unit. Failure to install the right valve can lead to poor performance and possible compressor damage.

**I. TXV Bulb Horizontal Mounting**

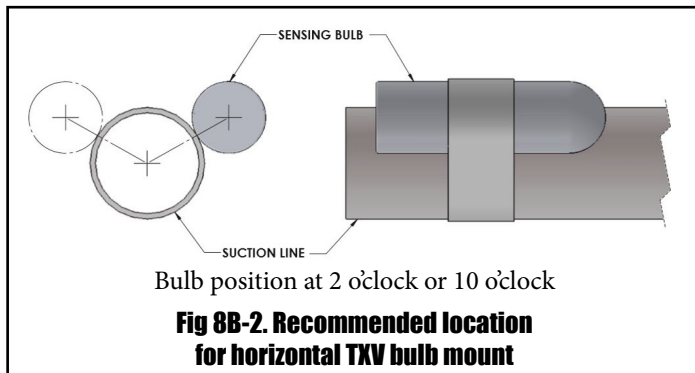
The orientation and location of the TXV bulb has a major influence on the system performance.



## CAUTION

Ensure that the TXV bulb is in direct contact with the suction/vapor line. Gap between the bulb and tube should be avoided. Failure to do so will impair the proper functioning of the TXV valve.

It is recommended that the TXV bulb be installed parallel to the ground (on a horizontal plane). The bulb position should be at 2 o'clock or 10 o'clock. Fig. 7B-2 shows the recommended position for the TXV bulb installation in the horizontal plane.

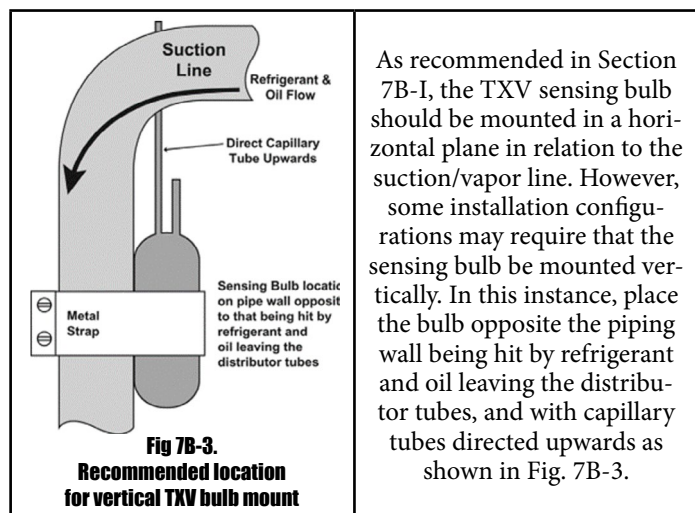


The TXV sensing bulb **SHOULD** be mounted on the suction line approximately 6" from the TXV or coil housing using the metal clamp provided. In order to obtain a good temperature reading and correct superheat control, the TXV sensing bulb must conform to ALL of the following criteria:

1. The sensing bulb **MUST** be in direct and continuous contact with the suction line.
2. The sensing bulb should be mounted horizontally on the suction line.
3. The sensing bulb **MUST** be mounted at the 2 o'clock or 10 o'clock position on the circumference of the suction line.
4. The sensing bulb **MUST** be insulated from outside air.

A properly mounted sensing bulb will prevent false readings caused by liquid refrigerant that may have formed inside the suction/vapor line. Insulation will protect the sensing bulb from false readings due to contact with warm air.

## II. TXV Bulb Vertical Mounting



As recommended in Section 7B-I, the TXV sensing bulb should be mounted in a horizontal plane in relation to the suction/vapor line. However, some installation configurations may require that the sensing bulb be mounted vertically. In this instance, place the bulb opposite the piping wall being hit by refrigerant and oil leaving the distributor tubes, and with capillary tubes directed upwards as shown in Fig. 7B-3.



## CAUTION

If the TXV sensing bulb is mounted vertically; the capillary **MUST** be directed upwards. The bulb must be mounted on the wall opposite to that being directly hit by the refrigerant and oil leaving the distributor tubes.

## III. Field-Installed TXV Retrofit

*NOTE: Photos are for basic illustration / reference purposes only. Actual equipment configuration may differ from that shown.*



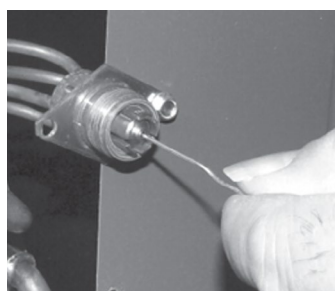
## WARNING

Do not attempt to touch brazed joints while hot. Severe burns may result.

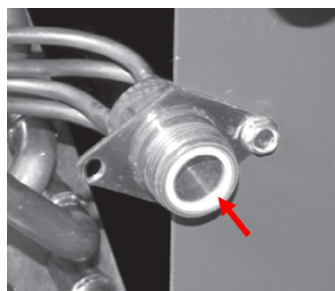
When installing an expansion valve, it is not necessary to slide the coil out of the housing.



III-1. Disassemble the flowrator body using two wrenches. Unscrew the body with a counter-clockwise motion.

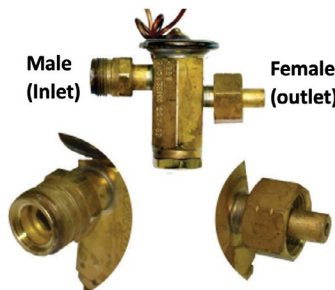


III-2. Remove the existing flowrator piston using a small wire or pick.

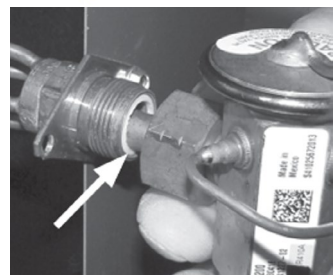


III-3. Replace the Teflon O-ring seal in place (located between the halves).

III-4. Inspect the TXV box to confirm that the valve is compatible with the refrigerant in the system.



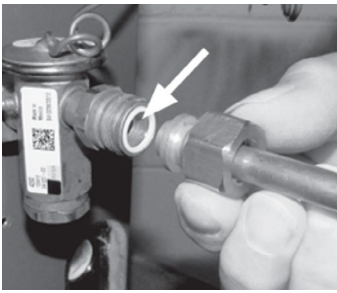
III-5. Remove the valve from the box and note the location of the inlet side (threaded male port) and the outlet side (female swivel nut port).



III-6. After ensuring that the Teflon O-ring seal is still in place inside the flowrator body, screw the female swivel nut onto the flowrator body.

III-7. Slide attachment the nut onto the liquid line stub out (See 7A, I-3)

III-8. Braze the stub-out portion to the liquid line and let cool.

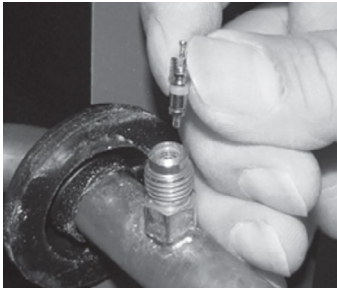


III-9. Remove the additional Teflon O-ring seal from the box and place on the shoulder just inside the TXV inlet port. Screw the nut attached to the stub-out portion of the flowrator body onto the inlet port of the TXV.

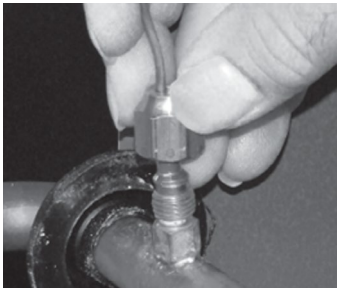
III-10. Tighten all connections taking care to use proper back up. Tighten the nut to a torque of approximately 10-30 ft-lbs.

III-11. Remove the valve identification sticker from the valve and place it adjacent to the Aspen model number on unit name plate.

III-12a. Some Aspen coils come with a Schrader valve on the suction line. If a Schrader port is present:



A. Remove the valve stem from the Schrader port mounted on the suction line.



B. Screw flare nut on TXV equalization tube on to the Schrader valve stem.



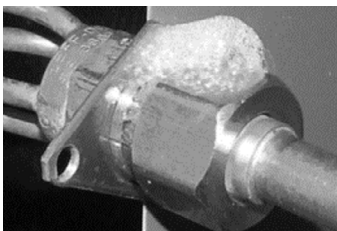
**CAUTION** When handling or manipulating the equalizer tube, take great care not to kink or make extreme bends in the tubing.



**CAUTION** Using a non-bleed expansion valve may require the use of a hard-start kit. Follow the outdoor unit manufacturer's guidelines.

## 9. Leak Check

- Following outdoor unit manufacturer instructions and recommendations, charge the system with dry nitrogen to a maximum pressure of 150 PSIG.
- Check all brazed and screw-on line connections by applying a soap solution to the joint. A leak will produce bubbles in the soap solution.



- If any leaks are discovered, relieve system pressure and repair leaks. Repeat steps 1-3.
- With no leaks or weak connections present, evacuate the system and charge as per the outdoor unit manufacturer instructions and specifications.



### NOTICE

Test pressures for A2L refrigerants, field made refrigerant joints shall have a sensitivity of 5 grams per year of refrigerant or at least 25 times the maximum allowable pressure. No leaks shall be detected in the systems.

## 10. System Charging



### WARNING

Units designed for use with R410a refrigerant **MUST** be charged with R410a refrigerant.



### WARNING

Units designed for use with R32 refrigerant **MUST** be charged with R32 refrigerant. Ensure that the R32 sensor is installed correctly and is operational.



### WARNING

Units designed for use with R454B refrigerant **MUST** be charged with R454B refrigerant. Ensure that the R454B sensor is installed correctly and is operational.



### CAUTION

An improperly charged system will likely cause loss in system performance and may damage the compressor.



### CAUTION

Refer to outdoor unit manufacturer charging guidelines and recommendations. The recommendations given below are general in nature and are **NOT** to supersede outdoor unit manufacturer specifications.

Where addition of charge is required to complete installation, instructions on how to determine the additional REFRIGERANT CHARGE and how to complete the REFRIGERANT CHARGE on the label provided by the outdoor unit manufacturer adjacent to the nameplate if the compressor bearing unit. Interconnecting refrigerant piping length and diameter shall be taken into consideration.

### Flowrator coil:

Add refrigerant until the superheat measured at the outdoor unit suction/vapor line matches the superheat from the chart below.

Outdoor Temp	Superheat			
	°F D.B.	Min	Nom	Max
65		30	35	40
70		26	30	34
75		21	25	29
80		17	20	23
85		12	15	18
90		8	10	12
95		4	5	7
100				



## TXV Coils:

If the unit is equipped with a **fixed TXV**, add refrigerant until the subcooling measures at the outdoor unit liquid line matches the subcooling recommendations of the outdoor manufacturer. If the charge is unavailable charge the unit to a subcooling value of 8°F +/- 1°F.

If the unit is equipped with an **adjustable TXV**, add refrigerant until the subcooling measures at the outdoor unit liquid line matches the subcooling recommendations of the outdoor manufacturer. If the charge is unavailable charge the unit to a subcooling value of 8°F +/- 1°F.



### NOTICE

**When adjusting the TXV, the valve stem or adjusting screw should not be adjusted more than a ¼ turn at a time. To adjust superheat, turn the valve stem clockwise to increase and counterclockwise to decrease.**

1. If subcooling and superheat are low, adjust TXV to 8°F +/- 1°F superheat, then check subcooling.
2. If subcooling is low and superheat is high, add charge to raise subcooling to 8°F +/- 1°F then check superheat.
3. If subcooling and superheat are high, adjust TXV valve to 8°F +/- 1°F superheat, then check subcooling.
4. If subcooling is high and superheat is low, adjust TXV valve to 8°F +/- 1°F superheat and remove charge to lower the subcooling to 8°F +/- 1°F.

The TXV should NOT be adjusted at light load / ambient conditions of 60°F or below.

## 11. Coil Cleaning Instructions



### WARNING

**Do not use means to accelerate the defrosting process or to clean, other than those recommended by the manufacture.**

Aspen cased coils are equipped with a two-piece panel door to allow for cleaning and maintenance access. Remove one or both doors to access the coil for cleaning.

For both copper and aluminum tube coils, it is recommended to flush with the coil with water. There are coil cleaners that are available that contain corrosive chemicals, such as, but not limited to, chlorine and hydroxide, that are not approved for use on Aspen copper and aluminum tube coils.

## 12. A2L Coils and Refrigerant Detection Systems



Read the precautions in this manual carefully before operating the unit.



Read the instructions in this manual carefully before operating the unit.



Read the instructions in this manual carefully before servicing the unit.



Read the instructions in this manual carefully before wiring the unit.

## 12.1 Installation, Service, Maintenance & Repair Instructions

Products designed for use with A2L Refrigerants are equipped with a refrigerant leak detection system (which includes an A2L Sensor, a Mitigation Control Board, and Harnesses) which must be wired to the furnace as specified in the Wiring Diagram.

The A2L Sensor must be installed and powered for service. On cased coils ensure that the strain relief is installed in the through the knockout hole in the access panel.



### WARNING

**Disconnect ALL power before servicing or installing this unit. Multiple power sources may be present. Failure to do so may cause property damage, personal injury, or death.**



### WARNING

**When using FLAMMABLE REFRIGERANTS, LEAK DETECTION SYSTEM installed. Unit must be powered except for service.**

For mechanical ventilation, the lower edge of the air extraction opening where air is exhausted from the room shall not be more than 100 mm above the floor. The location where the mechanical ventilation air extracted from the space is discharged shall be separated by a sufficient distance, but not less than 3 m, from the mechanical ventilation air intake openings, to prevent recirculation to the space.



### WARNING

**Refrigerating pipe or components are installed in a position where they are unlikely to be exposed to any substance which may corrode refrigerant containing components, unless the components are constructed of materials which are inherently resistant to being corroded or are suitably protected against being so corroded.**

False ceilings or drop ceilings may be used as a return air plenum only if a refrigerant detection system is provided in the appliance and any external connections are also provided with a sensor immediately below the return air plenum duct joint.



### WARNING

**Auxiliary devices which may be a POTENTIAL IGNITION SOURCE shall not be installed in the duct work. Examples of such POTENTIAL IGNITION SOURCES are hot surfaces with a temperature exceeding 700°C and electric switching devices.**



### WARNING

**Only auxiliary devices approved by the appliance manufacturer or declared suitable with the refrigerant shall be installed in connecting ductwork.**

### 12.1.1 Qualification of workers

Only technicians with training carried out by national training organizations or manufacturers that are accredited to teach the relevant national competency standards that may be set in legislation may work on this equipment. The achieved competence must be documented by a certificate.

### 12.1.2 Checks to the work area & Work procedure

Prior to work taking place, the area around the equipment is to be surveyed to make sure that there are no flammable hazards or ignition risks.

Work shall be undertaken under a controlled procedure so as to minimize the risk of a flammable gas or vapor being present while the work is being performed.

All maintenance staff and others working in the local area shall be instructed on the nature of work being carried out. Work in confined spaces shall be avoided.

### 12.1.3 Checking for presence of refrigerant

The area shall be checked with an appropriate refrigerant detector prior to and during work, to ensure the technician is aware of potentially toxic or flammable atmospheres.

Ensure that the leak detection equipment being used is suitable for use with all applicable refrigerants, i.e. non-sparking, adequately sealed or intrinsically safe.

### **12.1.4 Presence of Fire Extinguisher**

If any hot work is to be conducted on the refrigerating equipment or any associated parts, appropriate fire extinguishing equipment shall be available to hand. Have a dry powder or CO2 fire extinguisher adjacent to the charging area.

### **12.1.5 No Ignition Sources**

No person carrying out work in relation to a REFRIGERATING SYSTEM which involves exposing any pipe work shall use any sources of ignition in such a manner that it may lead to the risk of fire or explosion. All possible ignition sources, including cigarette smoking, should be kept sufficiently far away from the site of installation, repairing, removing and disposal, during which refrigerant can possibly be released to the surrounding space. Prior to work taking place, the area around the equipment is to be surveyed to make sure that there are no flammable hazards or ignition risks. "NO SMOKING" signs shall be displayed.

### **12.1.6 Ventilated Area**

Ensure that the area is in the open or that it is adequately ventilated before breaking into the system or conducting any hot work. A degree of ventilation shall continue during the period that the work is carried out. The ventilation should safely disperse any released refrigerant and preferably expel it externally into the atmosphere.

### **12.1.7 Checks to the refrigerating equipment**

Where electrical components are being changed, they shall be fit for the purpose and to the correct specification. At all times the manufacturer's maintenance and service guidelines shall be followed. If in doubt, consult the manufacturer's technical department for assistance.

The following checks shall be applied to installations using FLAMMABLE REFRIGERANTS:

- The actual REFRIGERANT CHARGE is in accordance with the room size within which the refrigerant containing parts are installed;
- The ventilation machinery and outlets are operating adequately and are not obstructed;
- Marking to the equipment continues to be visible and legible. Markings and signs that are illegible shall be corrected;
- Refrigerating pipe or components are installed in a position where they are unlikely to be exposed to any substance which may corrode refrigerant containing components, unless the components are constructed of materials which are inherently resistant to being corroded or are suitably protected against being so corroded.

### **12.1.8 Checks to electrical devices**

Repair and maintenance to electrical components shall include initial safety checks and component inspection procedures. If a fault exists that could compromise safety, then no electrical supply shall be connected to the circuit until it is satisfactorily dealt with. If the fault cannot be corrected immediately but it is necessary to continue operation, an adequate temporary solution shall be used. This shall be reported to the owner of the equipment so all parties are advised.

Initial Safety Checks shall include:

- That capacitors are discharged: this shall be done in a safe manner to avoid possibility of sparking;
- That no live electrical components and wiring are exposed while charging, recovering or purging the system;
- That there is continuity of earth bonding.

### **12.1.9 Repairs to sealed electrical components**

During repairs to sealed electrical components, all electrical supplies shall be disconnected from the equipment being worked upon prior to any removal of sealed covers, etc. If it is absolutely necessary to have an electrical supply to equipment during servicing, then a permanently operating form of leak detection shall be located at the most critical point to warn of a potentially hazardous situation.

Particular attention shall be paid to the following to ensure that by working on electrical components, the casing is not altered in such a way that the level of protection is affected. This shall include damage to cables, excessive number of connections, terminals not made to original specification, damage to seals, incorrect fitting of glands, etc.

Ensure that the apparatus is mounted securely.

Ensure that seals or sealing materials have not degraded to the point that they no longer serve the purpose of preventing the ingress of flammable atmospheres. Replacement parts shall be in accordance with the manufacturer's specifications.

### **12.1.10 Cabling**

Check that cabling will not be subject to wear, corrosion, excessive pressure, vibration, sharp edges or any other adverse environmental effects. The check shall also take into account the effects of aging or continual vibration from sources such as compressors or fans.

### **12.1.11 Detection of Flammable Refrigerants**

Under no circumstances shall potential sources of ignition be used in the searching for or detection of refrigerant leaks. A halide torch (or any other detector using a naked flame) shall not be used.

Electronic leak detectors may be used to detect refrigerant leaks but, in the case of FLAMMABLE REFRIGERANTS, the sensitivity may not be adequate, or may need re-calibration. (Detection equipment shall be calibrated in a refrigerant-free area.) Ensure that the detector is not a potential source of ignition and is suitable for the refrigerant used. Leak detection equipment shall be set at a percentage of the LFL of the refrigerant and shall be calibrated to the refrigerant employed, and the appropriate percentage of gas (15 % maximum) is confirmed.

Leak detection fluids such as the bubble method is also suitable for use with most refrigerants but the use of detergents containing chlorine shall be avoided as the chlorine may react with the refrigerant and corrode the copper pipe-work. If a leak is suspected, all naked flames shall be removed/extinguished. If a leakage of refrigerant is found which requires brazing, all of the refrigerant shall be recovered from the system, or isolated (by means of shut off valves) in a part of the system remote from the leak.

### **12.1.12 Removal and Evacuation**

When breaking into the refrigerant circuit to make repairs – or for any other purpose – conventional procedures shall be used. However, for FLAMMABLE REFRIGERANTS it is important that best practice is followed since flammability is a consideration. The following procedure shall be adhered to:

- safely remove refrigerant following local and national regulations;
- evacuate;
- purge the circuit with inert gas (optional for A2L);
- evacuate (optional for A2L);
- continuously flush or purge with inert gas when using flame to open circuit; and
- open the circuit.

The refrigerant charge shall be recovered into the correct recovery cylinders if venting is not allowed by local and national codes. For

appliances containing flammable refrigerants, the system shall be purged with oxygen-free nitrogen to render the appliance safe for flammable refrigerants. This process might need to be repeated several times. Compressed air or oxygen shall not be used for purging refrigerant systems.

For appliances containing flammable refrigerants, refrigerant purging shall be achieved by breaking the vacuum in the system with oxygen-free nitrogen and continuing until the working pressure is achieved, then venting to the atmosphere, and finally pulling down to a vacuum (optional for A2L). This process shall be repeated until no refrigerant is within the system (optional for A2L). When the final oxygen-free nitrogen charge is used, the system shall be vented down to atmospheric pressure to enable work to take place.

The outlet for the vacuum pump shall not be close to any potential ignition sources, and ventilation shall be available.

### 12.1.13 Charging Procedures

In addition to conventional charging procedures, the following requirements shall be followed.

- Ensure that contamination of different refrigerants does not occur when using charging equipment.
- Hoses or lines shall be as short as possible to minimize the amount of refrigerant contained in them.
- Cylinders shall be kept in an appropriate position according to the instructions.
- Ensure that the REFRIGERATING SYSTEM is earthed prior to charging the system with refrigerant.
- Label the system when charging is complete (if not already).
- Extreme care shall be taken not to overfill the REFRIGERATING SYSTEM.

Prior to recharging the system, it shall be pressure-tested with the appropriate purging gas. The system shall be leak-tested on completion of charging but prior to commissioning. A follow up leak test shall be carried out prior to leaving the site.

### 12.1.14 Decommissioning

Before carrying out this procedure, it is essential that the technician is completely familiar with the equipment and all its detail. It is recommended good practice that all refrigerants are recovered safely. Prior to the task being carried out, an oil and refrigerant sample shall be taken in case analysis is required prior to re-use of recovered refrigerant. It is essential that electrical power is available before the task is commenced.

- a) Become familiar with the equipment and its operation.
- b) Isolate system electrically.
- c) Before attempting the procedure, ensure that:
  - mechanical handling equipment is available, if required, for handling refrigerant cylinders;
  - all personal protective equipment is available and being used correctly;
  - the recovery process is supervised at all times by a competent person;
  - recovery equipment and cylinders conform to the appropriate standards.
- d) Pump down refrigerant system, if possible.
- e) If a vacuum is not possible, make a manifold so that refrigerant can be removed from various parts of the system.
- f) Make sure that cylinder is situated on the scales before recovery takes place.
- g) Start the recovery machine and operate in accordance with instructions.
- h) Do not overfill cylinders (no more than 80 % volume liquid charge).
- i) Do not exceed the maximum working pressure of the cylinder, even temporarily.

### 12.1.14 Decommissioning CONTINUED

- j) When the cylinders have been filled correctly and the process completed, make sure that the cylinders and the equipment are removed from site promptly and all isolation valves on the equipment are closed off.
- k) Recovered refrigerant shall not be charged into another REFRIGERATING SYSTEM unless it has been cleaned and checked.

### 12.1.15 Labeling

Equipment shall be labelled stating that it has been de-commissioned and emptied of refrigerant. The label shall be dated and signed. For appliances containing FLAMMABLE REFRIGERANTS, ensure that there are labels on the equipment stating that the equipment contains FLAMMABLE REFRIGERANT.

### 12.1.16 Recovery

When removing refrigerant from a system, either for servicing or decommissioning, it is recommended good practice that all refrigerants are removed safely.

When transferring refrigerant into cylinders, ensure that only appropriate refrigerant recovery cylinders are employed. Ensure that the correct number of cylinders for holding the total system charge is available. All cylinders to be used are designated for the recovered refrigerant and labelled for that refrigerant (i.e. special cylinders for the recovery of refrigerant). Cylinders shall be complete with pressure-relief valve and associated shut-off valves in good working order. Empty recovery cylinders are evacuated and, if possible, cooled before recovery occurs.

The recovery equipment shall be in good working order with a set of instructions concerning the equipment that is at hand and shall be suitable for the recovery of the flammable refrigerant. If in doubt, the manufacturer should be consulted. In addition, a set of calibrated weighing scales shall be available and in good working order. Hoses shall be complete with leak-free disconnect couplings and in good condition.

The recovered refrigerant shall be processed according to local legislation in the correct recovery cylinder, and the relevant waste transfer note arranged. Do not mix refrigerants in recovery units and especially not in cylinders.

If compressors or compressor oils are to be removed, ensure that they have been evacuated to an acceptable level to make certain that flammable refrigerant does not remain within the lubricant. The compressor body shall not be heated by an open flame or other ignition sources to accelerate this process. When oil is drained from a system, it shall be carried out safely.

## 12.2 RDS: Sensor, Mitigation Control, and Wiring

Refer to Table 12.2A for R32 and Table 12.2B for R454B below for minimum conditioned room requirements.

Wiring instructions are detailed in the wiring diagrams in Section 13 of this manual. All wiring installed in the field used with the RDS must meet the following specifications:

- 18 AWG
- 1.58mm insulation thickness or protected from damage

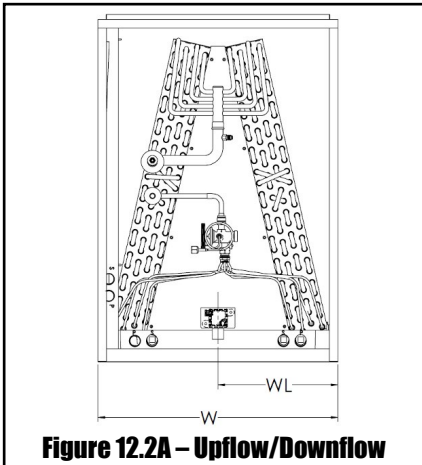
The installation of the RDS and sensor location will vary depending on the product configuration and direction of airflow. Follow instructions in this manual carefully. Units with factory installed RDS are configured for upflow/downflow installation as shown in Figure 12.2A. The sensor can be relocated for horizontal left & right installation as shown in Figure 12.2B

It is the installer's responsibility to ensure that mitigation mode is operational. The functionality can be tested after the installation.

The A2L sensor is not intended for service or repair. If the sensor

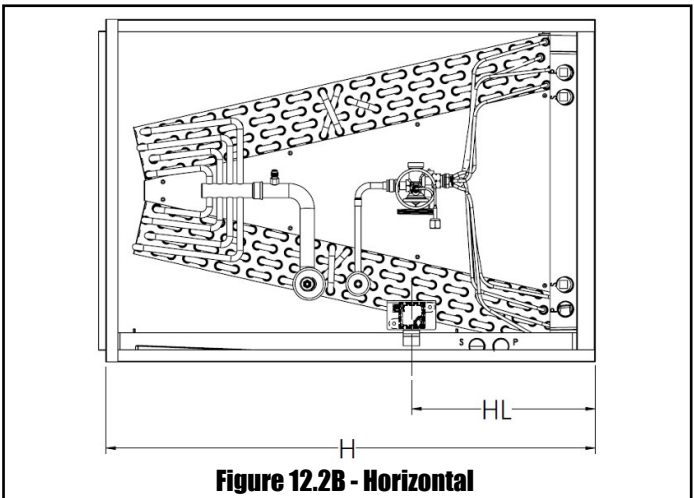
is not functioning properly, mitigation mode will engage and the sensor must be replaced by removing the sensor and sensor clip assembly from the drain pan and replacing with a new sensor and sensor clip assembly.

**WARNING** Refrigerant sensors for refrigerant detection systems shall only be replaced with sensors specified by the appliance manufacture.



**Figure 12.2A – Upflow/Downflow**

VERTICAL - Table 12.2 A	
CABINET WIDTH (W) inches	SENSOR LOCATION (WL) inches
14.0	7.00
14.5	7.25
17.0	8.50
17.5	8.75
21.0	10.50
24.0	12.00
24.5	12.25



**Figure 12.2B - Horizontal**

HORIZONTAL - Table 12.2 B	
CABINET HEIGHT (H) inches	SENSOR LOCATION (HL) inches
19	5.25
23	11.25
27	11.25
30	11.25

Minimum Mitigation Airflow for R32 Systems (Table 12.2 C)						
Total System Charge (lb)	Total System Charge (oz)	Total System Charge (kg)	Minimum Room Area (m <sup>2</sup> )	Minimum Room Area (ft <sup>2</sup> )	Minimum Mitigation Airflow (m <sup>3</sup> /hr)	Minimum Mitigation Airflow (CFM)
4	64	1.81	5.39	58.02	177.88	105
5	80	2.27	6.74	72.53	222.35	131
6	96	2.72	8.09	87.03	266.82	157
7	112	3.18	9.43	101.54	311.29	183
8	128	3.63	10.78	116.04	355.76	209
9	144	4.08	12.13	130.55	400.23	236
10	160	4.54	13.48	145.05	444.70	262
11	176	4.99	14.82	159.56	489.17	288
12	192	5.44	16.17	174.06	533.64	314
13	208	5.90	17.52	188.57	578.11	340
14	224	6.35	18.87	203.07	622.58	366
15	240	6.80	20.21	217.58	667.05	393
16	256	7.26	21.56	232.08	711.52	419
17	272	7.71	22.91	246.59	755.99	445
18	288	8.16	24.26	261.09	800.46	471
19	304	8.62	25.60	275.60	844.93	497
20	320	9.07	26.95	290.10	889.40	523

**NOTE:** The installer should verify the actuation of the mitigation procedure, as well as the airflow according to the chart. The installer should refer to the airflow table provided by the furnace or blower manufacturer.

Minimum Mitigation Airflow for R454B Systems (Table 12.2 D)						
Total System Charge (lb)	Total System Charge (oz)	Total System Charge (kg)	Minimum Room Area (m <sup>2</sup> )	Minimum Room Area (ft <sup>2</sup> )	Minimum Mitigation Airflow (m <sup>3</sup> /hr)	Minimum Mitigation Airflow (CFM)
4	64	1.81	5.57	59.98	183.89	108
5	80	2.27	6.97	74.98	229.86	135
6	96	2.72	8.36	89.97	275.83	162
7	112	3.18	9.75	104.97	321.81	189
8	128	3.63	11.14	119.96	367.78	216
9	144	4.08	12.54	134.96	413.75	244
10	160	4.54	13.93	149.95	459.72	271
11	176	4.99	15.32	164.95	505.69	298
12	192	5.44	16.72	179.94	551.67	325
13	208	5.90	18.11	194.94	597.64	352
14	224	6.35	19.50	209.93	643.61	379
15	240	6.80	20.90	224.93	689.58	406
16	256	7.26	22.29	239.92	735.55	433
17	272	7.71	23.68	254.92	781.53	460
18	288	8.16	25.08	269.92	827.50	487
19	304	8.62	26.47	284.91	873.47	514
20	320	9.07	27.86	299.91	919.44	541

**NOTE:** The installer should verify the actuation of the mitigation procedure, as well as the airflow according to the chart. The installer should refer to the airflow table provided by the furnace or blower manufacturer.

**NOTE:** The Total System Charge in the above tables, 12.2C and 12.2D is the total system charge which is marked on the system as specified in the outdoor unit manufacturer's instructions.

The mitigation requirements for evaporator coils using A2L refrigerants are calculated at sea level. For altitudes above 800 meters, the minimum conditioned area must be adjusted by the corresponding altitude adjustment factor (AF) shown in the reference table on the next page.

HEIGHT / Altitude (m)	HEIGHT / Altitude (ft)	ALTITUDE ADJUSTMENT FACTOR
0	0	1.00
200	656	1.00
400	1312	1.00
600	1969	1.00
800	2625	1.02
1000	3281	1.05
1200	3937	1.07
1400	4593	1.10
1600	5349	1.12
1800	5906	1.15
2000	6562	1.18
2200	7218	1.21
2400	7874	1.25
2600	8530	1.28
2800	9186	1.32
3000	9843	1.36
3200	10499	1.40

The Mitigation Control Board is an add-on control module that provides refrigerant leak detection and mitigation response for systems utilizing A2L-type refrigerants. The Mitigation Control Board can monitor up to two A2L Sensors, depending on the system's needs. The control module will constantly monitor the A2L Sensor(s) for a refrigerant leak condition. **When the A2L Sensor detects a concentration of refrigerant which meets or exceeds the Lower Flammability Limit (%LFL), the control module locks out the compressor and activates the ventilating fan.**

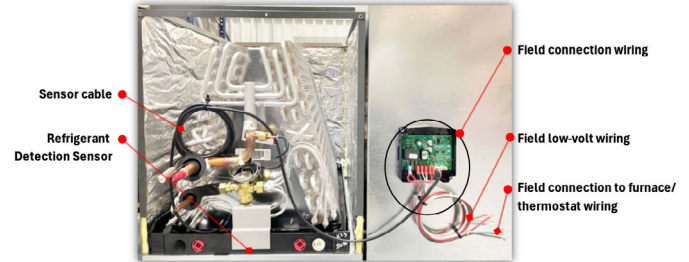
The Mitigation Control Board control module is certified as a Class B safety control and conforms to the guidelines set forth in Annex LL of UL standard 60335-2-40:

- a. The control will communicate with an external A2L Sensor in order to request data on the concentration of airborne refrigerant within the system enclosure.
- b. The control will provide a system response (i.e. deactivate the compressor, energize a ventilating fan, and provide an alarm indication) in the event of a reported concentration of at least 15% of the Lower Flammability Limit (determined by refrigerant composition). The system response (also referred to as the "mitigation state" or "safe state") must last for at least 5 minutes from initial fault detection.
- c. The control will only be able to recover operation if the system response has been active for at least 5 minutes and the A2L Sensor reports a concentration of refrigerant less than 8% LFL.
- d. Loss of communication between the control and the A2L Sensor will also result in the mitigation state for at least 5 minutes. The control will not recover until communication is restored.

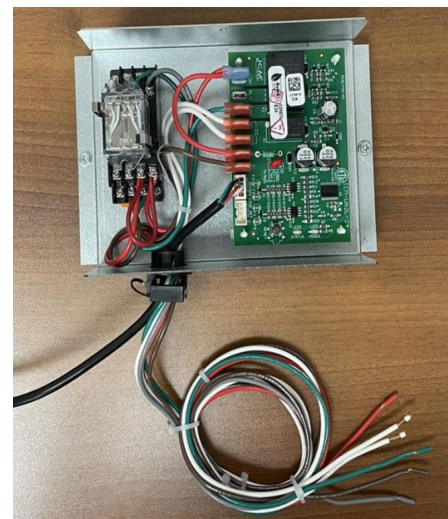
### 12.3 RDS: Installation of Sensor, Mitigation Control, and Wiring

The mitigation control system consists of a refrigerant detection sensor mounted on a sensor bracket, wire harness connecting the sensor to the mitigation board, a control board with a mitigation control board and optional relay, and a wire harness for connecting the system to a new/existing field wiring/air moving system

Refer to Figure-12.3A and 12.3B below for complete system:



**Fig 12.3 A - Mitigation Control System**

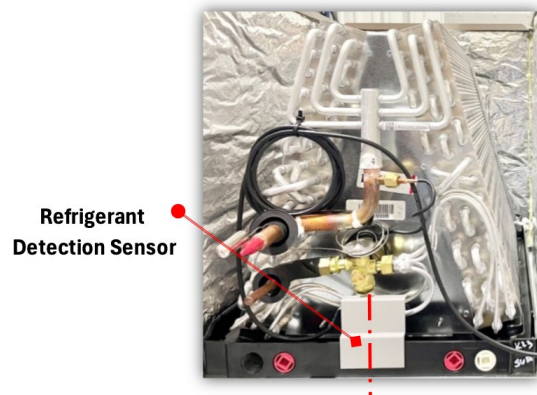


**Fig 12.3 B**

**INSTALLATION:** The mitigation system is required to be installed in the field by an A2L-trained HVAC contractor at the time of installation following these steps:

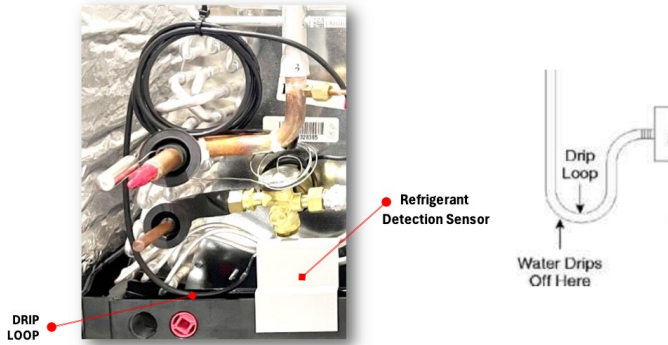
**12.3.1** Slide the uncased coil into the field provided coil casing. Slide the red discs (one for the liquid and suction line each) over the field piping and away from the brazing area. Follow the instruction guidelines outlined in Section 7 of this manual for brazing and installing the evaporator coil.

**12.3.2.** Attach sensor bracket, ensuring it is in the vertical position, on the drain pan as shown in Figure-B below:



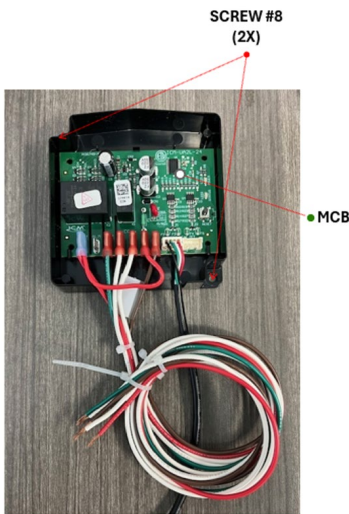
**Fig 12.4**

**12.3.3.** Run sensor cable through an opening in the casing. Use grommet supplied in the kit for hole (0.875”) in the sheet metal to ensure cable is not damaged when exiting the coil casing. The installer must ensure there is a drip loop (shown in Figure-12.5 below) in the harness to ensure condensation does not run into the sensor connection.

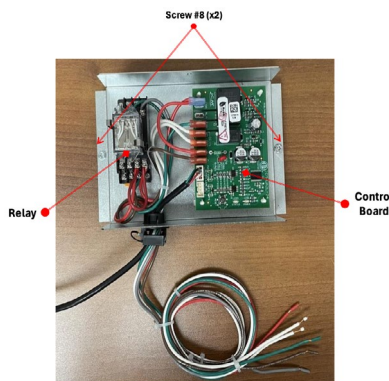


**Fig 12.5**

**12.3.4.** Mount mitigation board enclosure to a nearby flat, vertical surface by using a.) the included two-sided tape or b.) using field-supplied screws; see Figure-12.6 below for more details. The enclosure must be mounted perpendicularly flush to a wall or permanent structure near the coil within three (3) feet of the furnace. Do NOT mount the enclosure to the outside of the furnace or evaporator coil casing as damage could occur to the equipment. Keep the enclosure clear of the furnace flue pipes.

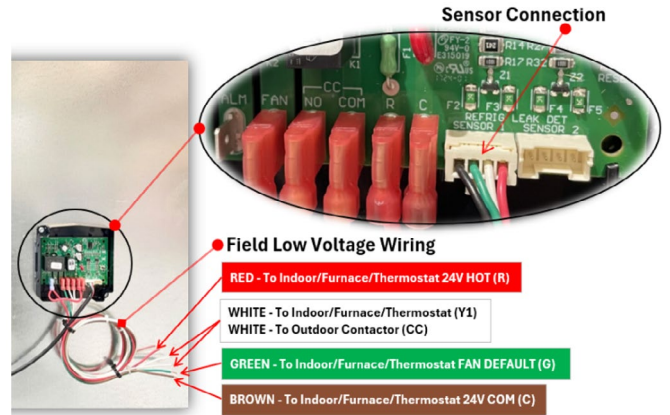


**Fig 12.6 A**



**Fig 12.6 B**

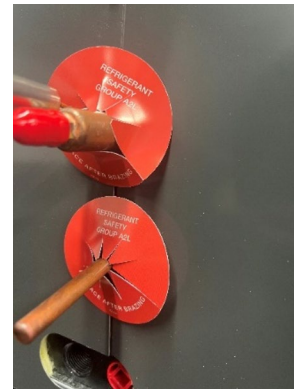
**12.3.5.** Connect the sensor cable to the control board in the enclosure. Connect the low-voltage wires into the existing/new wiring / air moving system as in Figure-12.7 to the next page:



**Fig 12.7**

Follow wiring instructions outlined in the wiring diagram in Section 13 of this manual

**12.3.6.** Close the casing holding the evaporator coil. Slide the discs so they reside just outside of the coil cabinet. See Figure-F below for pictorial representation. These markings will alert any technician servicing the installation in the future that the system is charged with an A2L refrigerant.



**Fig 12.8 A**

o For Uncased Coil applications: Apply warning labels included in the kit to the coil casing, ensuring they are visible from the front of the coil. See example below of the labels applied:



**Fig 12.8 B**

**RUNNING THE SYSTEM TEST IS MANDATORY FOR ALL INSTALLATIONS. THE HVAC SYSTEM MUST NOT COMPLETE COMMISSIONING UNTIL THE INSTALLATION STEPS OUTLINED IN THIS MANUAL HAVE BEEN SUCCESSFULLY COMPLETED.**

**IMPORTANT: NEVER CONNECT SENSOR TO THE MITIGATION CONTROL BOARD WHILE IT IS POWERED UP. ONLY USE THE "SENSOR1" PORT, THE "SENSOR2" PORT SHALL ONLY BE USED IN APPLICATIONS WITH TWO INDOOR UNITS IN WHICH THE SENSOR FROM THE SECOND INDOOR UNIT WILL ALSO CONNECT TO THE MITIGATION CONTROL BOARD. ALWAYS ENSURE THAT THE SYSTEM IS POWERED OFF BEFORE CONNECTING THE SENSOR TO THE MITIGATION CONTROL BOARD. IF THE SENSOR IS NOT CONNECTED BEFORE POWERING UP, THE SYSTEM WILL ENTER LEAK MITIGATION MODE. ONCE THE SYSTEM ENTERS LEAK MITIGATION MODE IT WILL STAY IN MITIGATION STATE FOR AT LEAST 5 MINUTES. THEREFORE, IT IS STRONGLY ADVISED TO CONNECT THE SENSORE BEFORE POWERING UP.**

Perform the A2L Mitigation Control refrigerant leakage test for all modes of operation one by one. – Cooling (for ACs & heat pumps), Heating (for heat pumps), Electric Heating, and Fan modes.

1. **Applications with Standard A2L Mitigation Kit:** Set

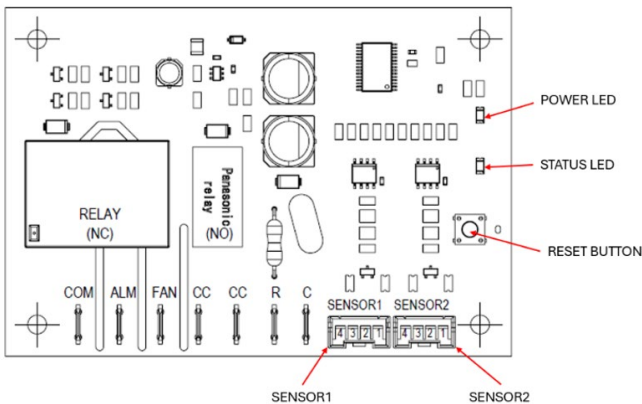
the thermostat to one of the above operation modes, and ensure that the system is powered and running properly in that mode. The test sequence will need to be performed again in each operation mode. Open the enclosure to access the mitigation control board. Once the system is powered, the control will communicate with the A2L sensor in order to request data on the concentration of airborne refrigerant within the coil cabinet. Wait 10 seconds, verify that the STATUS LED shows Warm-Up mode (solid ON), then wait 20 – 30 seconds and verify that the STATUS LED shows Run mode (solid OFF).

- a. Locate the sensor cable connected to the "SENSOR1" port on the mitigation control board. Remove the sensor cable by squeezing the tab on the connector and pulling away from the board to disconnect the sensor.

- c. Cycle the system power off, reconnect the sensor to the "SENSOR1" port, then power up the system to verify that the STATUS LED shows Warm-Up mode (solid ON). Wait 20-30s, then verify that the STATUS LED shows Run mode (solid OFF). For systems that only require one sensor, the test is complete.

**NOTE: IF THE A2L REFRIGERANT DETECTION SYSTEM IS NOT FUNCTIONING PROPERLY FOR ANY OF THE OPERATION MODES, RE-CHECK THE WIRING DIAGRAM FOR YOUR INSTALLED SYSTEM AND DO NOT CONTINUE UNTIL THE ISSUE HAS BEEN RESOLVED.**

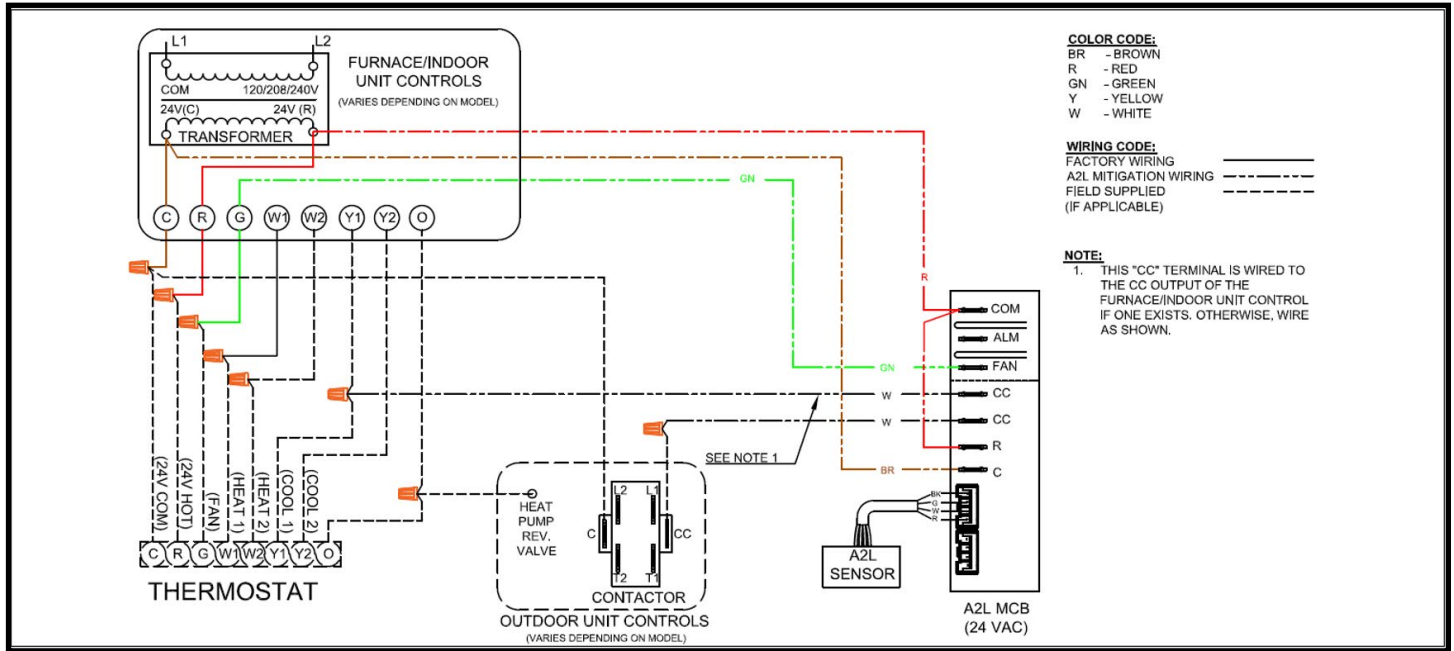
**NOTE: Loss of communication between the control and the sensor will also result in the mitigation state for at least 5 minutes. The control will not recover until communication is restored.**



**Fig 2.9**

- b. Once the sensor is disconnected, wait 15 seconds. When the mitigation control board no longer detects the sensor, verify that the STATUS LED blinks fault code for communication fault (2 blinks). The mitigation sequence begins:
  - i. The mitigation control board will provide a system response which will deactivate the compressor and energize the indoor blower.
  - ii. The indoor blower will remain running for at least 5 minutes from initial fault detection. The STATUS LED (2 blink) fault code will continue for the entire 5 minutes.
  - iii. Once steps b. i., and b. ii. have been confirmed the test is considered successful. It is recommended to wait the entire 5 minutes to verify the minimum fault duration.

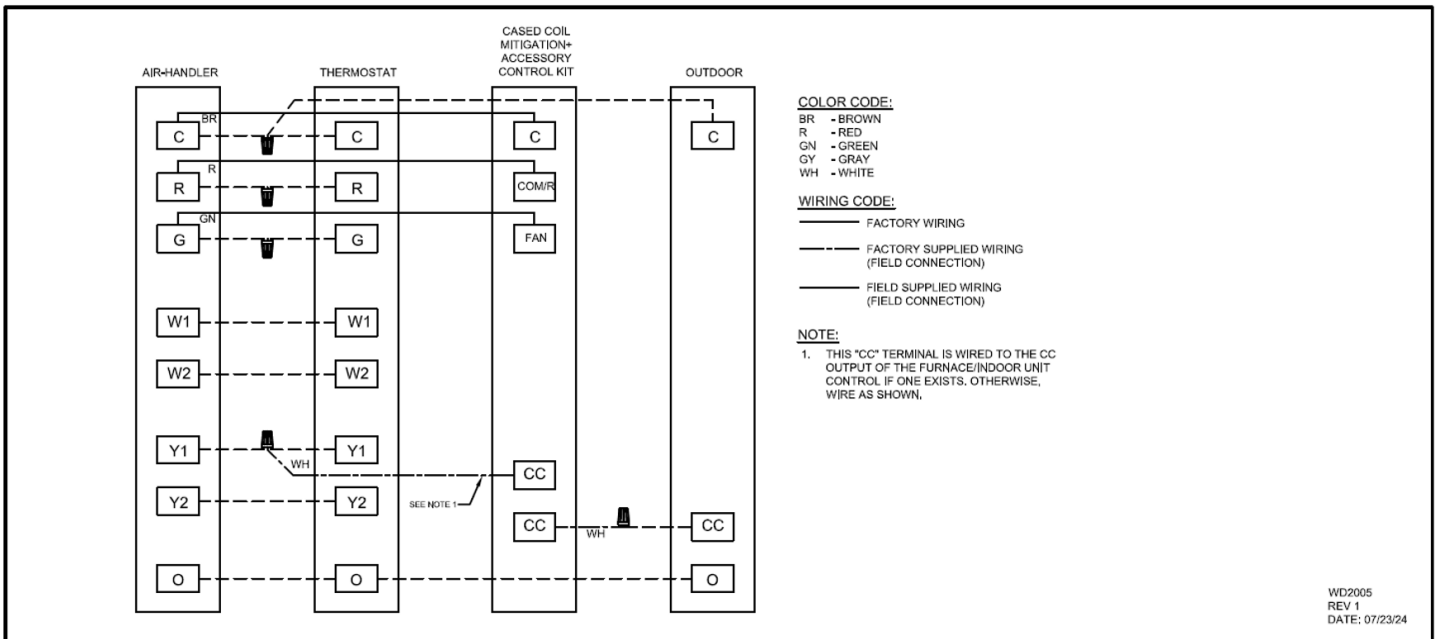
# 13. Wiring Diagrams



**Standard A2L Mitigation Kit Wiring Diagram**

**Fig 13.1**

**NOTE: Wiring Diagram is subject to change. Always refer to the wiring diagram on the unit for the most up-to-date wiring.**

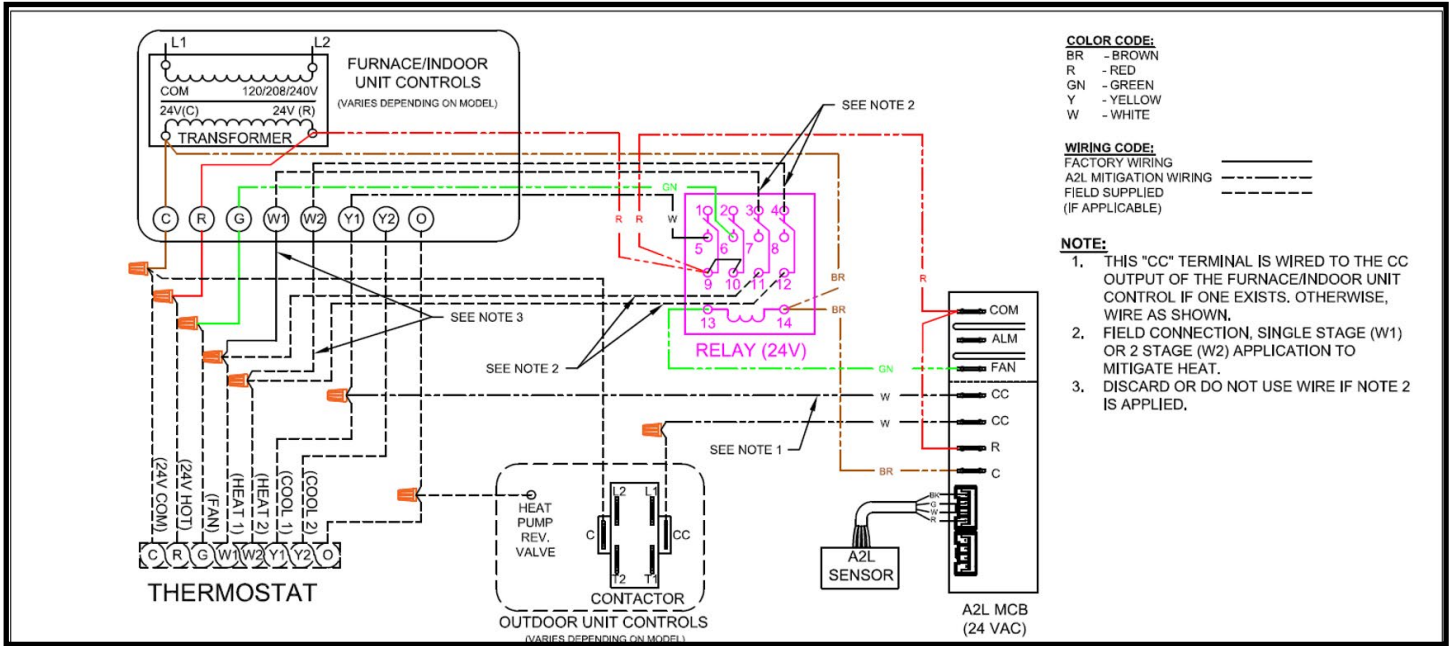


**Fig 13.2**

**NOTE: Wiring Diagram is subject to change. Always refer to the wiring diagram on the unit for the most up-to-date wiring.**



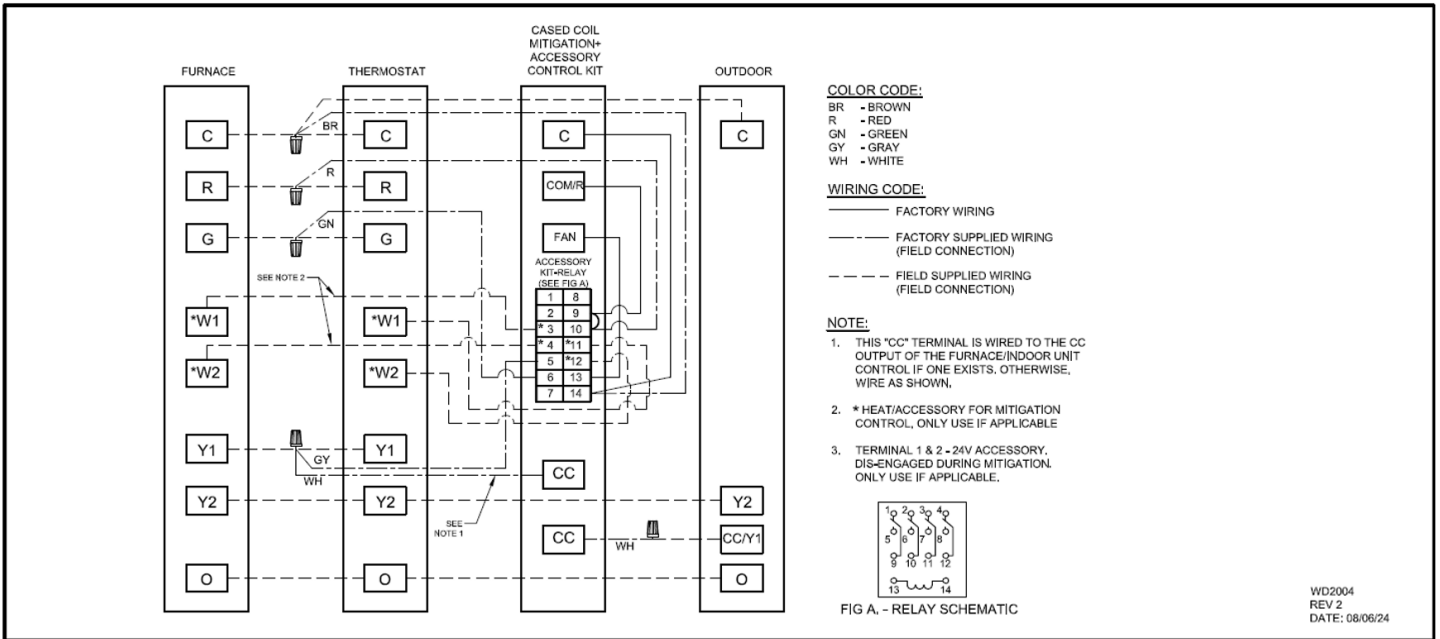
# 13. Wiring Diagrams CONTINUED



**A2L Mitigation + Accessory Kit Wiring Diagram**

**Fig 13.3**

**NOTE: Wiring Diagram is subject to change. Always refer to the wiring diagram on the unit for the most up-to-date wiring.**



**Fig 13.4**

**NOTE: Wiring Diagram is subject to change. Always refer to the wiring diagram on the unit for the most up-to-date wiring.**



373 Atascocita Rd.  
Humble, TX 77396  
Phone: 281.441.6500  
Toll Free: 800.423.9007  
Fax: 281.441.6510  
**[www.aspenmfg.com](http://www.aspenmfg.com)**



Revised 08-2024. Subject to change without notice and without incurring obligation.

© Copyright 2024 Aspen Manufacturing. All Rights Reserved